



Technical Data

//// Harmattan WP 215 LOM Basic

2-stage, air-cooled, direct drive, oil-less

Medium: Air



- Oil-less, dry-running compressor for oil-free air acc. to class 0 (ISO8573-1)
- Full mass balancing due to state-of-the-art boxer design
- Silent and smooth running characteristics
- Flat construction due to horizontal cylinders
- Vertically split crankcase for easy maintenance
- Built crankshaft with one-piece bearings

- Sauer offers the very latest compressors, control systems, compressed-air treatment systems and accessories
- Optimum customer services – starting with the initial enquiry and extending over the entire life of the product
- Customized solutions produced in accordance with customers' specifications
- Customer-specific documentation and calculations
- Individual, customer-oriented service plans

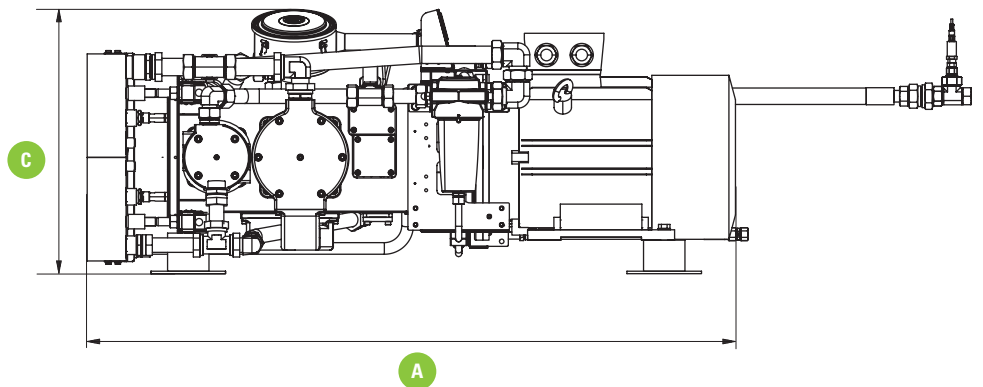
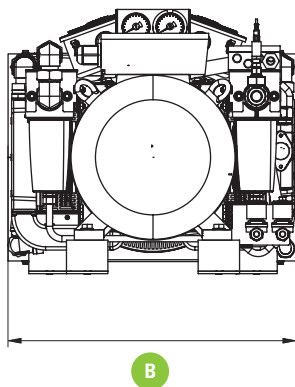

HARMATTAN

	Dimensions (mm)			Outlet Connection	Drainage Connection	Weight (kg)
	A	B	C	D	E	
WP 215 LOM Basic	1,600	720	620	Ø28 ISO 8434-1	Ø15 ISO 8434-1	460

PERFORMANCE DATA

MODEL	Speed [rpm]	11 bar (g) [m³/h]	13 bar (g) [m³/h]	15 bar (g) [m³/h]	Rated Power [kW]	Sound Pressure dB(A)@1m
WP 215 LOM Basic	1,500	183.0	181.0	179.0	37.0	88
	1,800	219.6	217.2	215.0	42.0	91

[m³/h] acc. to ISO 1217 ref 1013 bar.a and 20°C; [dB(A)] acc. to DIN 45635

STANDARD ACCESSORIES

	WP 215 LOM Basic
Air intake filter	✓
Intercooler and final after-cooler	✓
Air pressure gauge @ both stages	✓
Air temperature `high´ alarm/trip (PT 1000)	✓
Axial air-blast cooling fan	✓
Safety valve at @ both stages	✓
Condensate (water) separator at 2nd stage	✓
Auto-drain system (water)	✓
2nd stage solenoid valve (230V/50–60Hz)	✓
Auto-unload Start relief integrated within the auto-drain system	✓
Flexible drive coupling and flywheel	✓
Auto Stop/Start pressure remote control – mounted (4–20 mA Signal)	✓
Resilient AV mounts	✓
Flex. Hose for air outlet (inc. final non-return valve)	✓
Flex. Hoses for condensate (water) drainage connection	✓
Terminal Connection Box, pre-wired ex works	✓
Color Munsell 7.5 BG 7/2 – Sauer light green-blue & Cylinder Black	✓

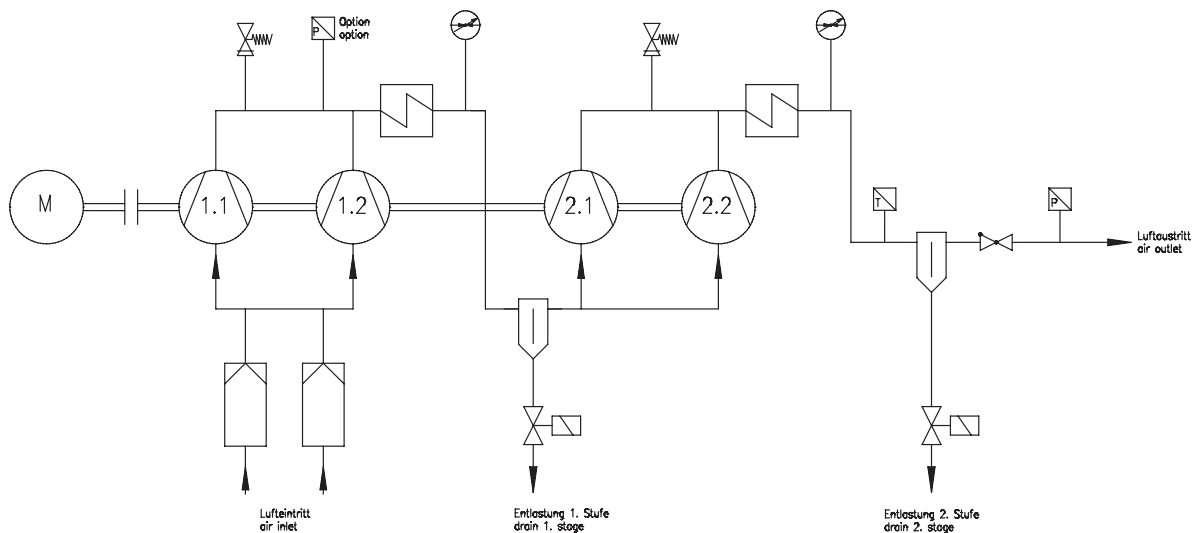

Dependable up to 500 bar – anywhere, anytime.

J.P. Sauer & Sohn Maschinenbau GmbH

PHONE + 49 431 3940-0
FAX + 49 431 3940-24

E-MAIL info@sauercompressors.de
WEB www.sauercompressors.com

