

DATA SHEET

KVX 3.140

ROTARY VANE VACUUM PUMPS

oil-free

air-cooled

MAKE IT BECKER.



figure KVX 3.80



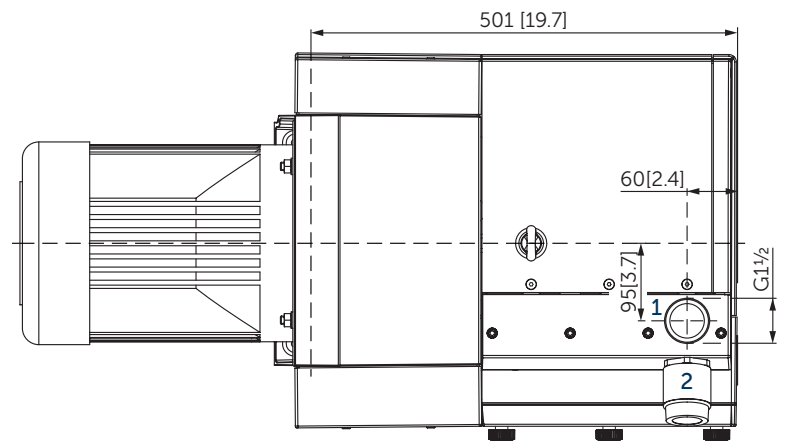
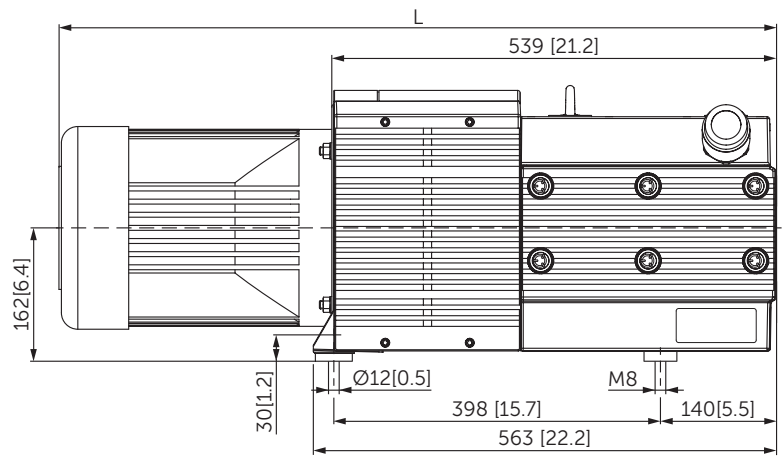
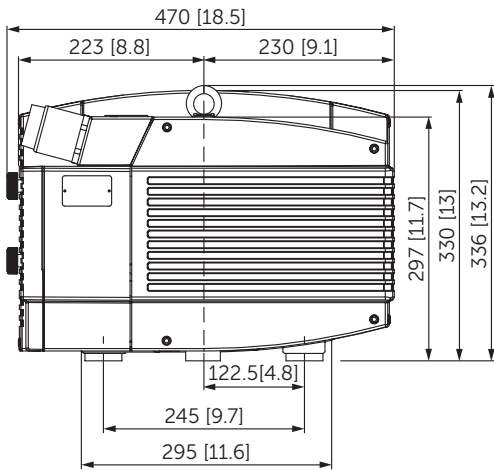

- 1 Vacuum connection (G1½)
- 2 Vacuum regulating valve
- Including integrated suction air filter and blow-off valve
- The motor illustration may vary.
- Dimensions in mm [inch]

Suction air rate		Vacuum absolute		Emission sound pressure level ¹⁾		Weight w/o motor
m ³ /h		mbar		dB(A)		kg
50 Hz	60 Hz	50 Hz	60 Hz	50 Hz	60 Hz	
129	154	100	200	76	79	78

¹⁾ According to DIN EN ISO 3744 (KpA = 3 dB(A)), 1 m [39.4 inch] distance, at medium load, both connection sides piped

3~ Motors												L	
#	50 Hz					60 Hz				Version	Weight kg	mm [inch]	
	kW	V	min ⁻¹	A	kW	V	min ⁻¹	A					
01	4.0	Δ230/Y400	IE3	1445	15.5/8.9	4.8	Δ265/Y460		1745	14.9/8.6	IP55 • ISO F • bimetal	34.0	829.0 [32.7]
							Δ230/Y400		1720	15.9/9.2			
02	4.0	Δ200/Y400	IE3	1465	18.0/9.0	4.5	YY230/Y460	IE3	1759	18.4/9.2	UL(E235514) • CSA CC329B IP55 • ISO F • bimetal	40.0	862.0 [34.0]
							YY208	IE3	1753	18.7			
03						4.8	YY230/Y460	IE3	1781	15.4/8.9	UL(E235514) • CSA CC329B IP55 • ISO F • bimetal	58.0	901.5 [35.5]
							YY208		1770	18.4			
04	4.0	Δ200/Y350	IE3	1467	20.3/11.7	4.5	Δ220/Y380-400	IE3	1760	18.5/10.7–10.2	UL(E235514) • CSA CC329B IP55 • ISO F • bimetal	40.0	862.0 [34.0]
							Δ200/Y350	IE3	1753	19.0/11.0			
05						4.5	Δ400/Y690	IE3	1768	11.0/6.35	UL(E235514) • CSA CC329B IP55 • ISO F • bimetal	40.0	862.0 [34.0]
06						4.8	Δ400/Y690	IE3	1775	10.75/6.2	UL(E365362) • CSA IP55 • ISO F • bimetal	64.5	966.5 [38.1]

- Current consumption and rotation speed may vary. Tolerance in each case -1.5/+2%

SERIES X: BECKER INNOVATION WITH TOP WARRANTY

Equipped with specially developed vanes, these oil-free rotary vane pumps distinguish themselves by high abrasion resistance, and with that extremely long service lives. Due to the low wear there is also minimal dust, so the series X pumps are perfectly suited for precision processes under clean room conditions.

This innovation branded by Becker is outstanding not only because of its 100 percent oil-free operation, excellent degree of efficiency and low power consumption.

In the area of sensitive vacuum, series X also guarantees precise low-pulsation air conduction.

Becker guarantees for these pumps a vane life-time of 20,000 operating hours or a maximum of 3 years. The enhanced longevity of X series pumps also extends service life intervals, and can cut out the need for frequent service visits with costly pump failures now no longer an issue.



ADVANTAGES

- Quick, clean and quiet
- Oil-free
- Wear resistant
- Energy saving
- Long-life reliability

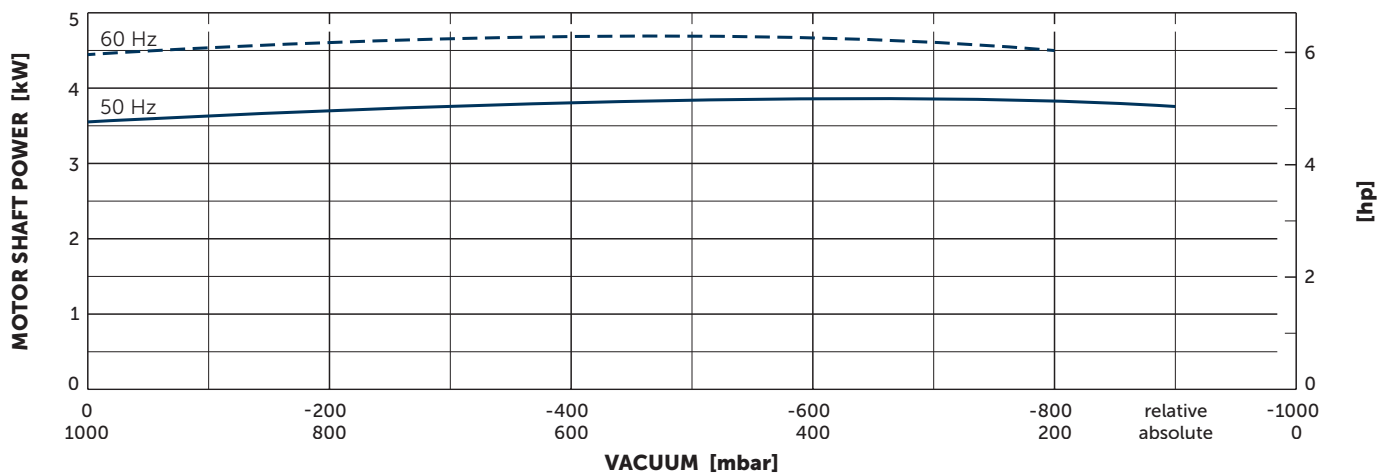
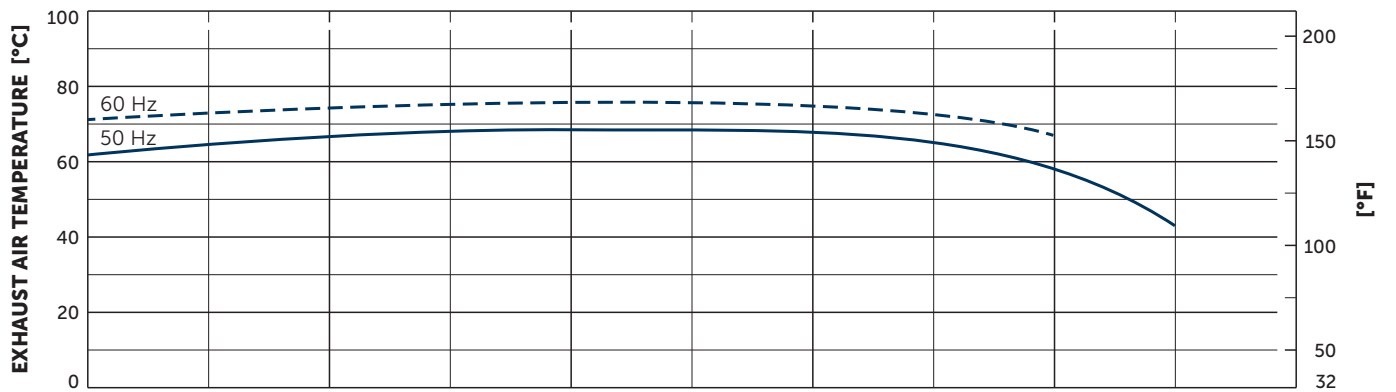
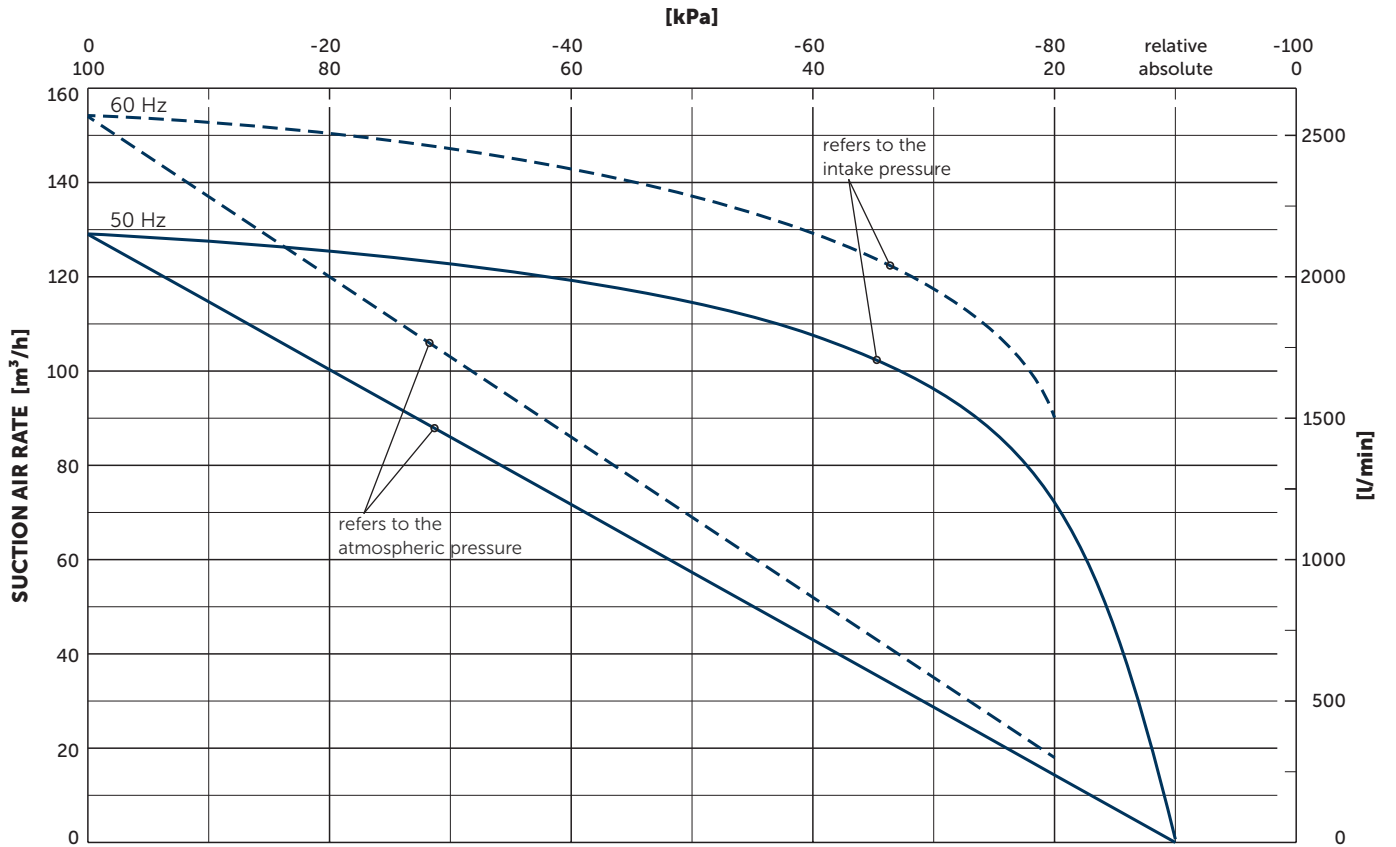

Reference data (atmosphere): 1000 mbar (100 kPa), 20°C (68°F)
Tolerance: ±5%

+ VARIANTS AND ACCESSORIES

OTHER VARIANTS AND ACCESSORIES

- **KVT 3.140/0-54** with exhaust connection
- **VARIAIR KVT 3.140/0-400** with frequency inverter¹⁾
- Increased corrosion protection
- External suction filter¹⁾
- Sound proof box SH 13¹⁾

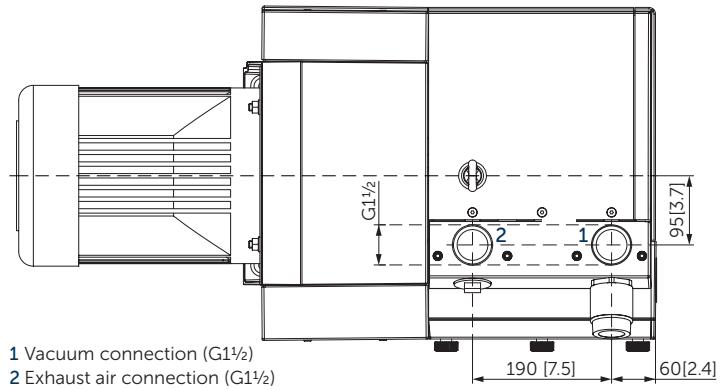

Example for an external suction filter



Sound proof box SH 13

¹⁾ See separate data sheet

- Possible combinations on request



MAKE IT BECKER.