

DATA SHEET

# VARIAIR BCV 100 CLAW VACUUM PUMPS



dry and contact free compression  
air-cooled, frequency inverter

---

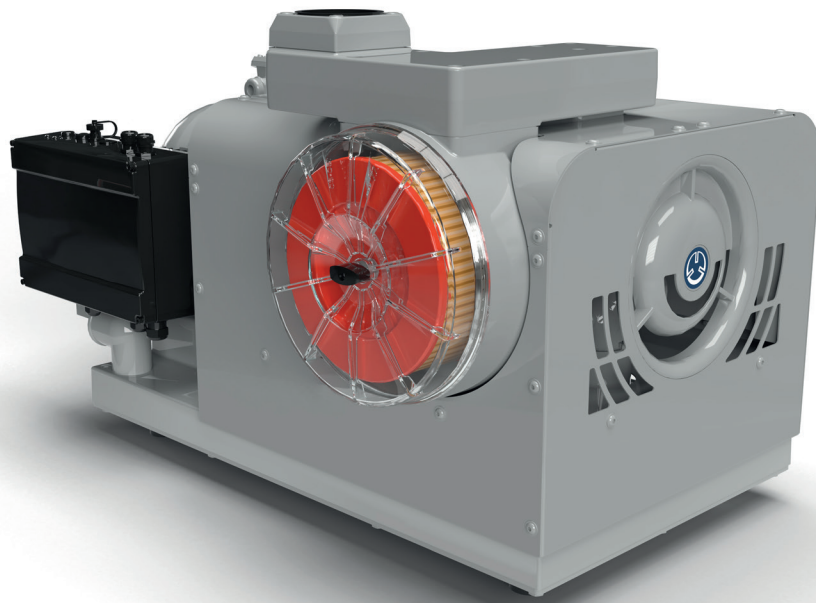
**MAKE IT BECKER.**

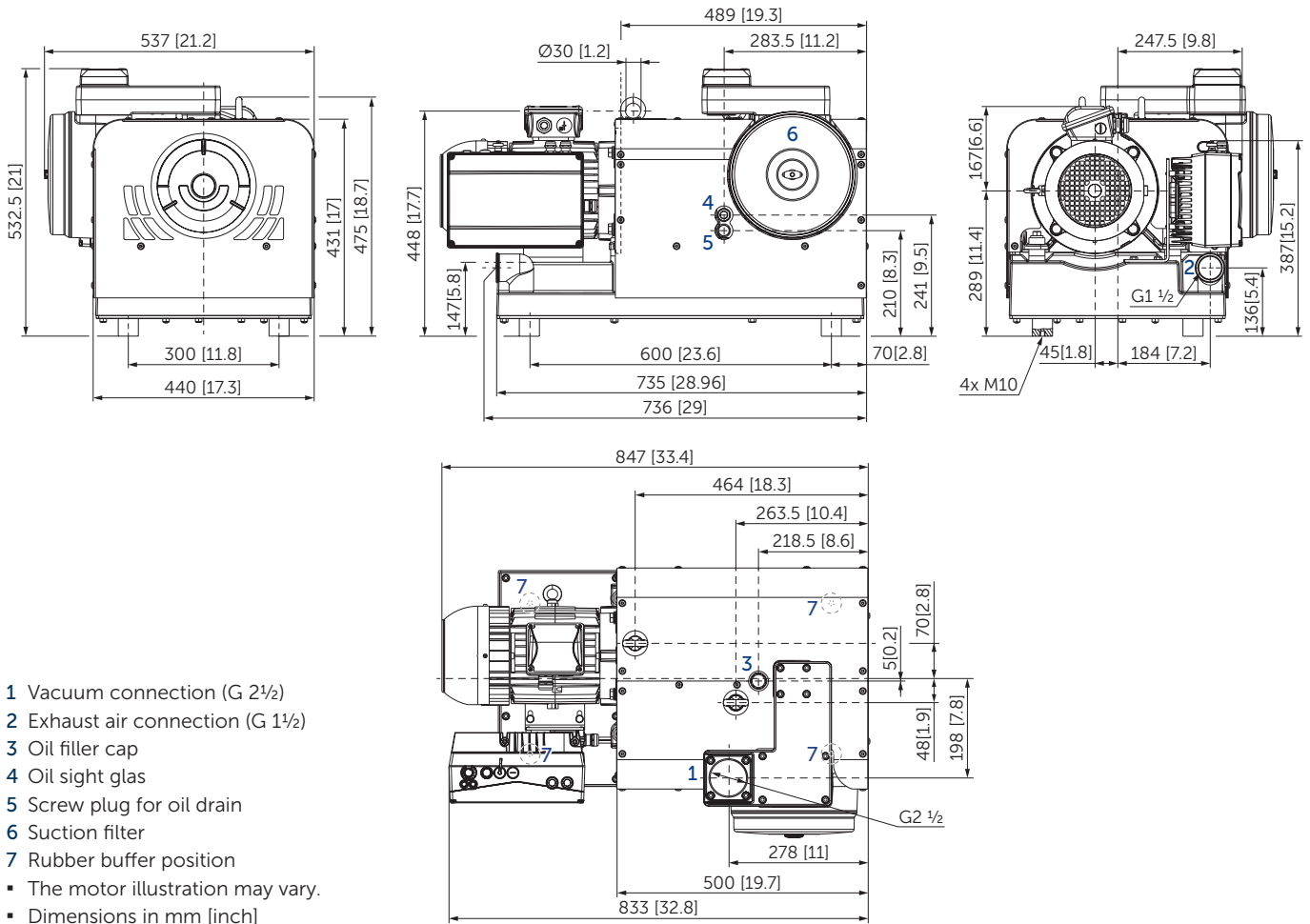



Nominal capacity	Vacuum absolute	Frequency	Emission sound pressure level <sup>1)</sup>	Weight		
m <sup>3</sup> /h max.	mbar max.	Hz	dB(A) @ 400 mbar (40 Hz)	kg	Frequency inverter VAU4/4	A max.
120	50	30–60	70	178	4.0 kW 400–480 V ±10% 50/60 Hz	6

<sup>1)</sup> According to DIN EN ISO 11203, accuracy class of measurement: class 2, extended measurement uncertainty: 3 dB  
 1 m [39.4 inch] distance, at medium load, both connection sides piped

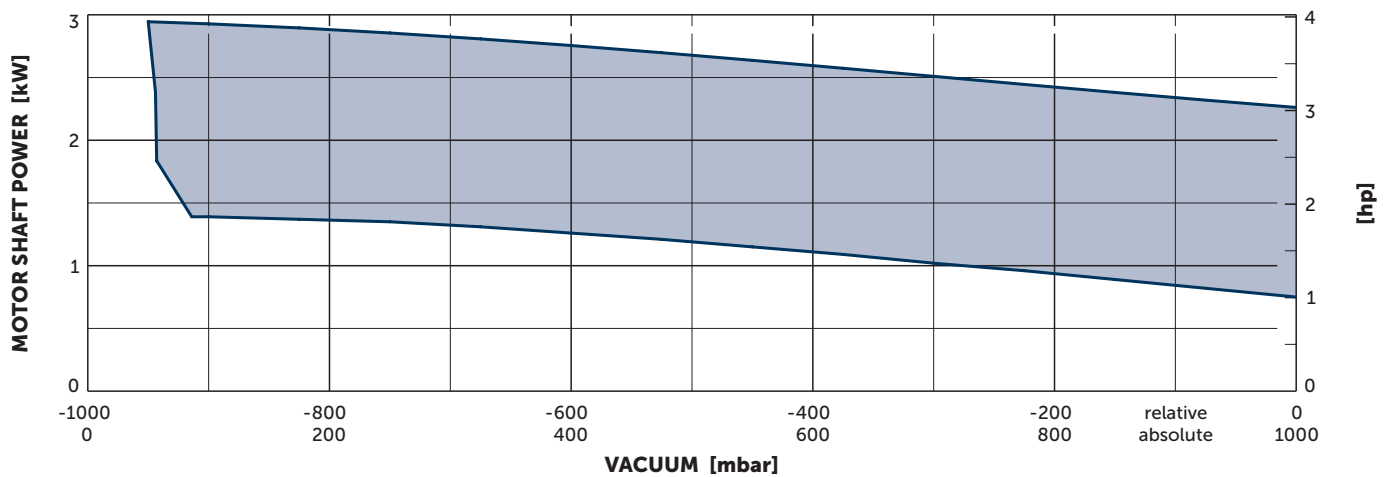
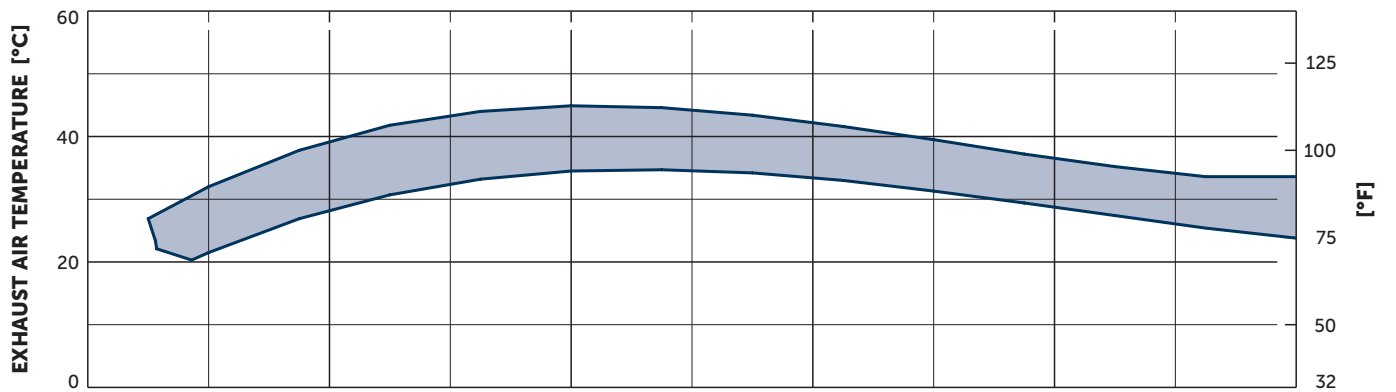
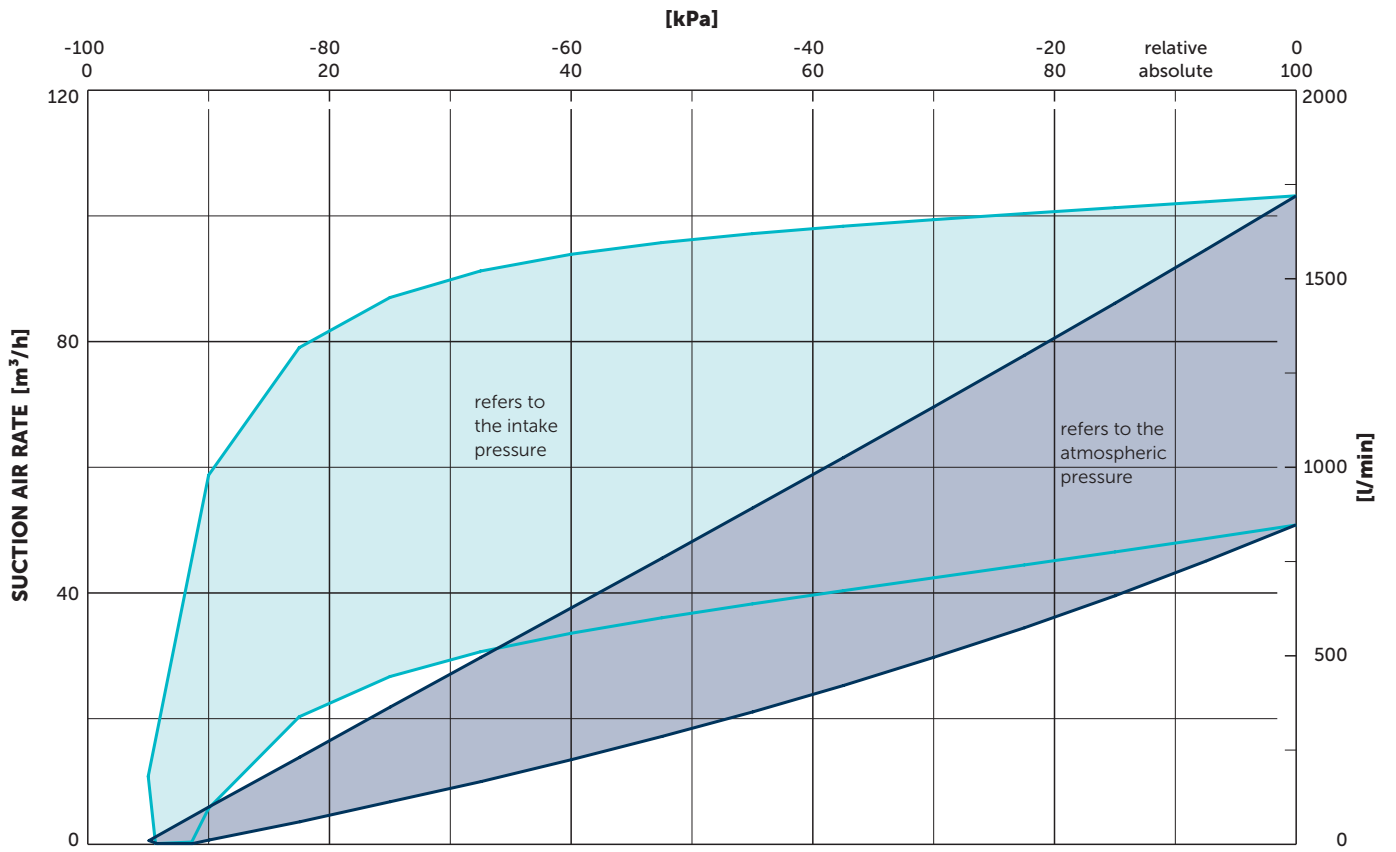

Reference data (atmosphere): 1000 mbar (100 kPa), 20°C (68°F), measurements with integrated filter  
 Tolerance: ±10%



**MAKE IT BECKER.**